

Drawings and Free Space

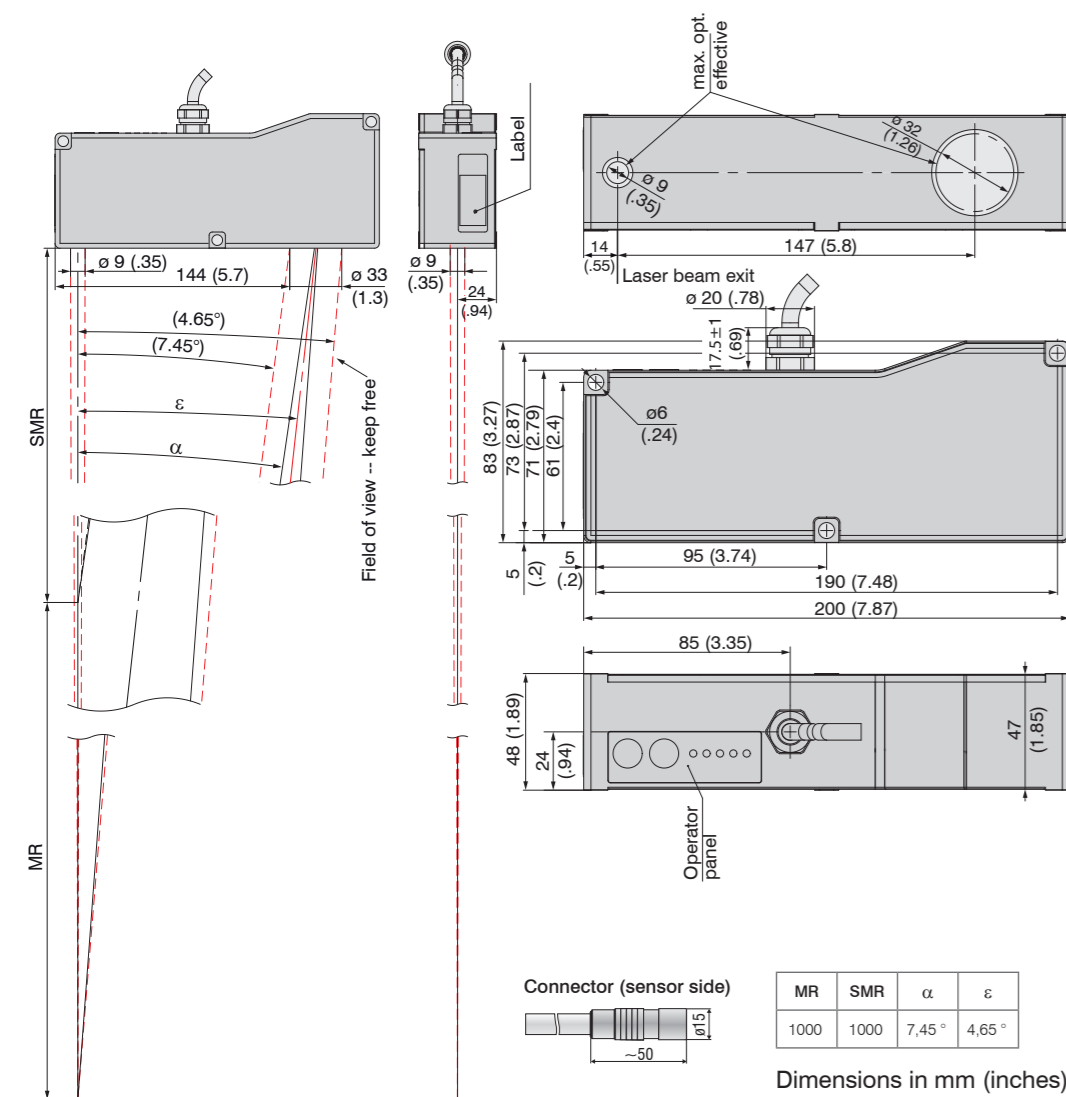

Optimizing the Measuring Accuracy

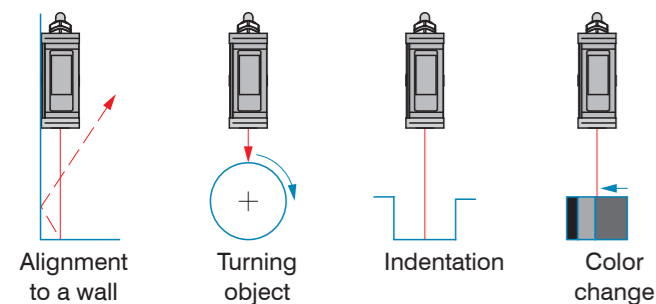

Sensor Mounting

The optoNCDT 1760 sensor is an optical system for measurements with micrometer accuracy.

Ensure careful handling during installation and operation!

- Mount the sensor only to the existing through-bores on a flat surface. Any type of clamping is not permitted.
- Use three M4 screws to mount the sensors. The bearing surfaces surrounding the through-holes (fastening holes) are slightly raised.

Bolt connection		
Bolt length		48 mm
Screw	ISO 4762-A2	M5
Washer	ISO 7089-A2	A5.3
Tightening torque	$\mu = 0.12$	3.5 Nm

Direct fastening		
Screwing depth	Minimum	9.6 mm
	Maximum	10 mm
Screw	ISO 4762-A2	M6
Tightening torque	$\mu = 0.12$	5 Nm

Measuring range, Start of Measuring range

Current	Voltage	Digital value ¹
3 mA	5.2 V / 10.2 V	262077
4 mA (SMR)	0 V	98232
12 mA (MMR)	2.5 V / 5 V	131000
20 mA (EMR)	5 V / 10 V	163768
3 mA	5.2 V / 10.2 V	262078

MR = Measuring range
SMR = Start of measuring range
MMR = Midrange
EMR = End of measuring range

1) For displacement values without zero setting or mastering.

Notes on Product Marking

The product meets the requirements of CE and UKCA. All specifications and safety instructions described in the operating instructions must be observed.

Inputs and Outputs

Signal	Pin	Description	Cable PC1700-x
V ₊	5	Supply voltage (11 ... 30 VDC)	Red
GND	6	System ground supply, switch signals (Laser on/off, Zero, Limits)	Black
Analog output	13	Current 4 ... 20 mA ($R_B < (V_+ - 6 V) / 20 \text{ mA}$)	Coaxial inner conductor, white
		Voltage 0 ... 5 VDC Voltage 0 ... 10 VDC ($R_1 = 50 \text{ Ohm}$, $I_{\text{max}} = 5 \text{ mA}$)	
AGND	14	Reference potential for analog output	Screening, black
Laser on/off	9	Switching input, Laser operates when pin 9 is connected to GND	Red and blue
Multi-function input	10	Switching input, TrigIn, Zero/Master, TeachIn, Slaveln	White and green
Switching output 1	8	Error/Limit 1	Gray and pink
Switching output 2	7	Limit 2, programmable switching characteristic: (NPN, PNP, Push-Pull)	Violet
Sync +	3	Symmetrical synchronous output (Master) or input (Slave) RS422 level, terminating resistor 120 Ohm switchable, input or output depends on selected synchronization mode	Blue
Sync -	4		Pink
Tx +	1	RS422 - Output (symmetric) terminate with 120 Ohm receive-site	Green
Tx -	2		Brown
Rx +	12	RS422 - Input (symmetric) internally terminated with 120 Ohm	Gray
Rx -	11		Yellow

View: Solder-pin side male cable connector, insulator

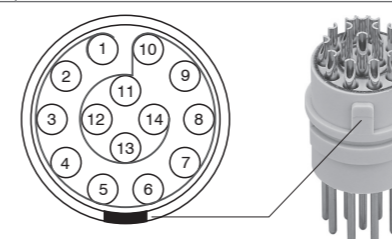

The PC1700 sensor cable is qualified for drag chain use. One end of the cable has a molded cable connector, the other end has braids with ferrules. Connector: ODU MINI-SNAP, 14 poles, B series, size 2, coding 0, IP 68

Supply Voltage, Nominal value: 24 V DC (11 ... 30 V, max. 150 mA).

Sensor Pin	PC1700-x/Y Color	Supply
5	Red	V ₊
6	Black	Ground

Use supply voltage for measurement instruments only. MICRO-EPSILON recommends using an optional available power supply unit PS2020 for the sensor.

MICRO-EPSILON MESSTECHNIK GmbH & Co. KG
Koenigbacher Str. 15 · 94496 Ortenburg / Germany
Tel. +49 (0) 8542 / 168-0 • Fax +49 (0) 8542 / 168-90
info@micro-epsilon.com • www.micro-epsilon.com

Your local contact: www.micro-epsilon.com/contact/worldwide/



X9771367.03-A022073D7a

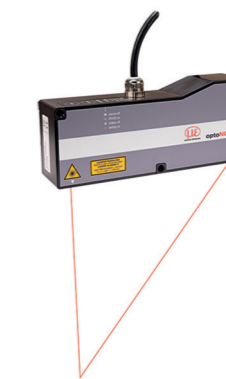

Proper Environment

- Protection class: IP65 (applies only when sensor cable is plugged in)
- Lenses are excluded from the protection class. Contamination of the lenses causes impairment or failure of the function.
- Temperature range:
 - Operation: 0 ... +50 °C (+32 ... +122 °F)
 - Storage: -20 ... +70 °C (-4 ... +158 °F)
- Humidity: 5 ... 95% RH (non-condensing)
- Ambient pressure: Atmospheric pressure

Warnings

Avoid unnecessary laser radiation to be exposed to the human body. Switch off the sensor for cleaning and maintenance, for system maintenance and repair if the sensor is integrated into a system. Caution - use of controls or adjustments or performance of procedures other than those specified may cause harm.

Connect the power supply and the display/output device in accordance with the safety regulations for electrical equipment. The power supply may not exceed the specified limits.
> Risk of injury. Damage to or destruction of the sensor.

Avoid continuous exposure to splashing water on the sensor and the controller. Avoid exposure to aggressive materials (washing agent, cooling emulsions) on the sensor.
> Damage to or destruction of the sensor.

Avoid shock and vibration to the sensor. Protect the sensor cable against damage.
> Damage to or destruction of the sensor, failure of the measuring device.

Laser Safety

The ILD1760 operates with a semiconductor laser with a wavelength of 670 nm (visible/red). The sensors fall within laser class 2. The following warning labels are attached to the cover (front and rear side) of the sensor housing:



CAUTION

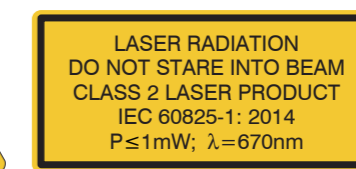

Laser radiation. Close your eyes or immediately turn away if the laser beam hits the eye. Irritation or injury of the eyes possible.

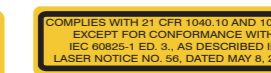

Only for USA



Assembly Instructions optoNCDT 1760

Laser On

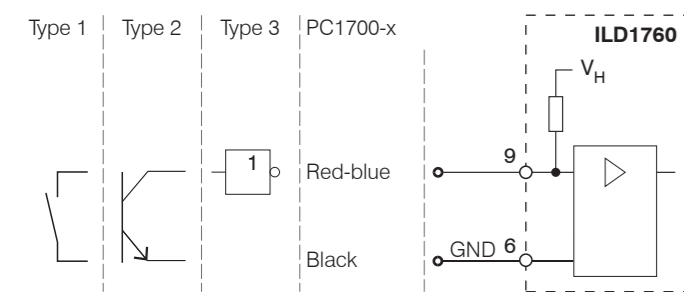

i If pin 9 is not connected with pin 6, the laser is off.

Analog Output

Current output 4 ... 20 mA or
Voltage output 0 ... 5 V or 0 ... 10 V

i The current output may not be continuously operated in short-circuit operation without load resistor. This would lead to thermal overload and thus to the automatic overload cut-off of the output.

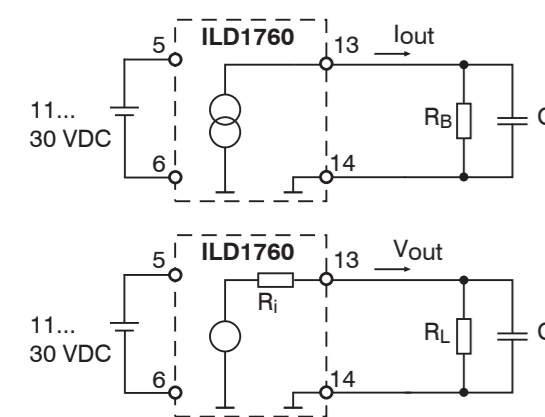

Current output
 $R_B < (V_+ - 6 V) / 20 \text{ mA}$;
 $R_B \text{ max.} = 250 \text{ Ohm at } V_+ = 11 \text{ V}$
 $C_i \leq 33 \text{ nF}$

Voltage output
 $R_i = 50 \text{ Ohm, } I_{\text{max}} = 5 \text{ mA}$,
Short circuit protection 7 mA
 $R_L > 20 \text{ MOhm}$
 $C_U \leq 100 \text{ nF}$

Multi-Function Input

The multi-function input enables triggering, zero setting/mastering and teaching. The function depends on the programming of the input and on the timing of the input signal.

The inputs are not electrically isolated. The maximum switching frequency is 10 kHz.

➔ Connect the input to **GND** to trigger the function.

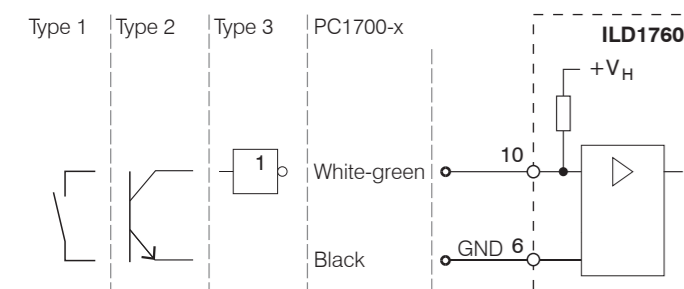

24 V logic (HTL):
Low level $\leq 3 \text{ V}$;
High level $\geq 8 \text{ V}$ (max 30 V)
5 V logic (TTL):
Low level $\leq 0.8 \text{ V}$;
High level $\geq 2 \text{ V}$
internal pull-up resistor, an open input is detected as High.

RS422 Connection with USB Converter IF2001/USB

Cross the lines for connections between sensor and PC.

i Disconnect or connect the D-sub connection between RS422 and USB converter when the sensor is disconnected from power supply only.

Sensor		End device (converter)
14-pin cable connector	Sensor cable	Type IF2001/USB from MICRO-EPSILON
Tx + (Pin 1)	Green	Rx + (Pin 3)
Tx -(Pin 2)	Brown	Rx -(Pin 4)
Rx + (Pin 12)	Gray	Tx + (Pin 1)
Rx -(Pin 11)	Yellow	Tx -(Pin 2)
GND (Pin 6)	Black	GND (Pin 9)



Symmetric differential signals acc. to EIA-422, not electrically isolated from supply voltage. Use a shielded cable with twisted cores e.g. PC1700-x.

Quick Guide

Components

➔ Mount the sensor and connect the components.

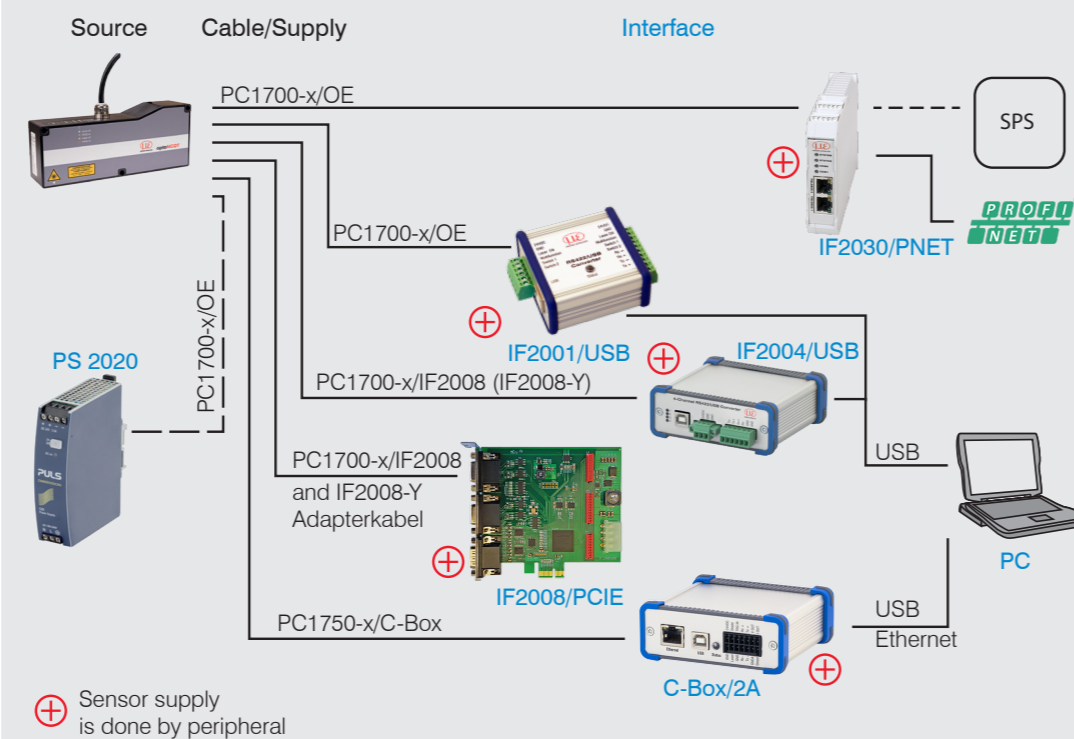

⊕ Sensor supply is done by peripheral

Initial Operation

- ➔ Connect the sensor to a PC/notebook via a RS422 connector. Connect the supply voltage.
- ➔ Start the program `sensorTOOL`.
- ➔ Click the `Sensor` button.

The program searches for connected ILD1760 sensors on available interfaces.

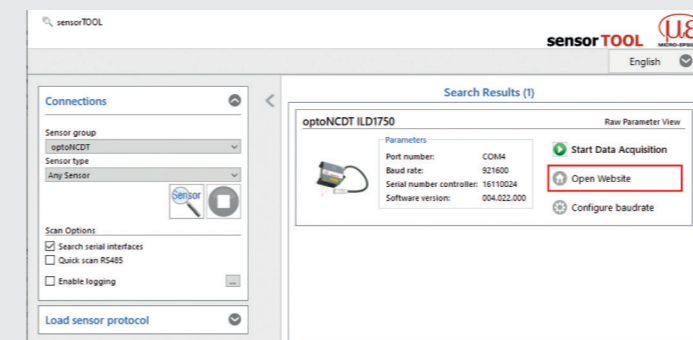

➔ Select the desired sensor. Click on the button `Open Website`.

Access via Web Interface

Interactive web pages for programming the sensor now appear in the web browser. The sensor is active and supplies measurement values. The ongoing measurement can be operated by means of function buttons in the area `Chart` type.

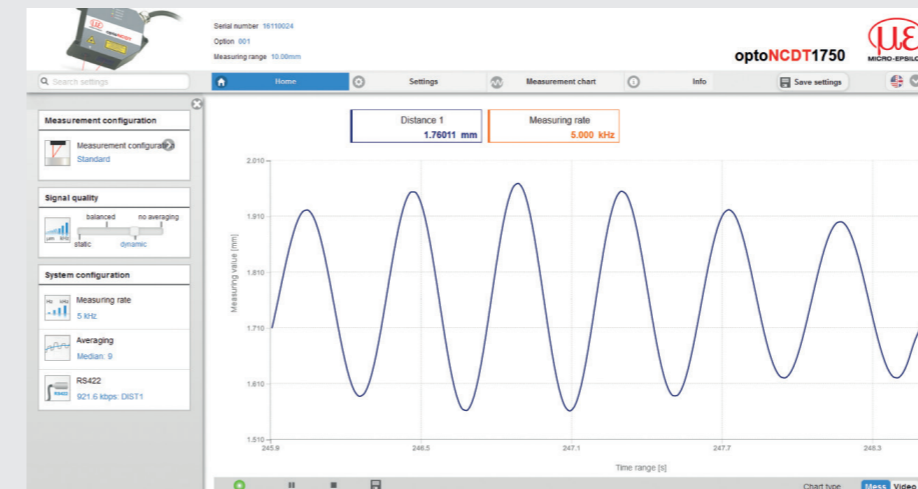

In the top navigation bar other auxiliary functions (settings, measurement chart etc.) are available. The appearance of the websites can change dependent of the functions. Each page contains descriptions of parameters and so tips for filling the website.

Select a Measuring Rate

- ➔ Go to the menu `Settings > Data recording > Measuring rate`.
- Start with a medium measuring rate. Select a measuring rate from the list.

Select an Interface

- ➔ Go to the menu `Settings > Output > Output interface`.

Defines which interface is used for output of measured values. A parallel output of measured values via multiple channels is not possible. RS422 and analog output cannot be operated simultaneously. While using the web interface, the output is switched off via RS422.

Place target

- ➔ Position the target (measurement object) as much as possible in the midrange.

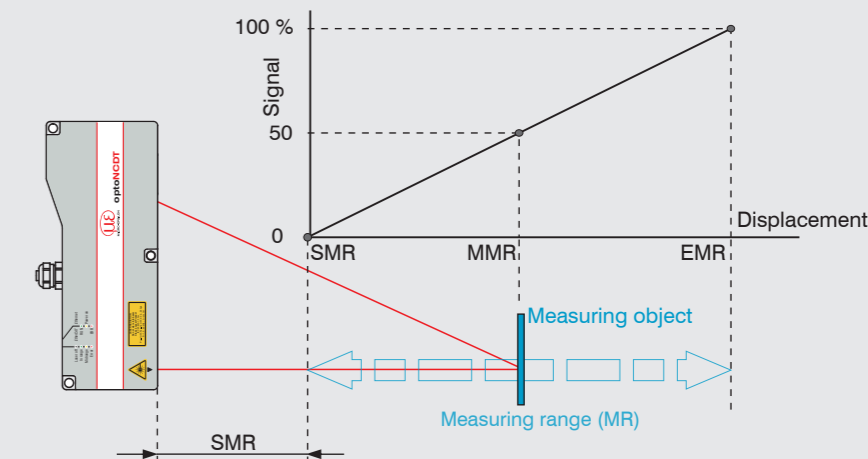

The State LED on the sensor indicates the position of the target to the sensor.

LED	Color	Labeling	Meaning
	Off	Laser off	Laser beam is switched off
State	Green	In range	Target within measuring range
	Yellow	Midrange	Target within the midrange
	Red	Error	Target outside the measuring range, too low reflection

Store the Settings

- ➔ Go to the menu `Settings > System settings > Load & Stores` or click the `Save settings` button.

You can find more information about the sensor in the operating instructions. They are online at www.micro-epsilon.com/download/manuals/man--optoNCDT-1750--en.pdf