



More Precision

optoNCDT // Laser displacement sensors (triangulation)





-  **Eight models with measuring ranges from 2 mm to 300 mm**
-  **Adjustable measuring rate up to 49.14 kHz**
- INTERFACE** **Ethernet / EtherCAT / RS422**
Analog output via C-Box
-  **Advanced Real Time Surface Compensation**
-  **Calibration certificate included**
-  **Measurement of diffuse and specular surfaces**
-  **Thickness measurement of transparent materials**
-  **Configuration via web interface**

The optoNCDT 2300 is the new, high performance version of Micro-Epsilon laser triangulation sensors and offers an adjustable measuring rate of up to 49.14 kHz. The entire electronics is already integrated in a compact sensor housing which is a worldwide unique feature of this sensor class. The new A-RTSC (Advanced Real Time

Surface Compensation) feature is a development of the company's already proven RTSC technology and, with its improved dynamic range, enables a more precise real time surface compensation during the measurement process. The threshold value of the compensation range can be easily configured via the software.

Data output is via Ethernet, RS422 or EtherCAT. The C-Box enables analog signal output. All sensor configurations are carried out using a user-friendly web interface. The optoNCDT 2300 is particularly used for high speed applications such as the monitoring of vibrations or measurements on challenging surfaces.

optoNCDT 2300-2 ... 2300-100
Diffuse reflection

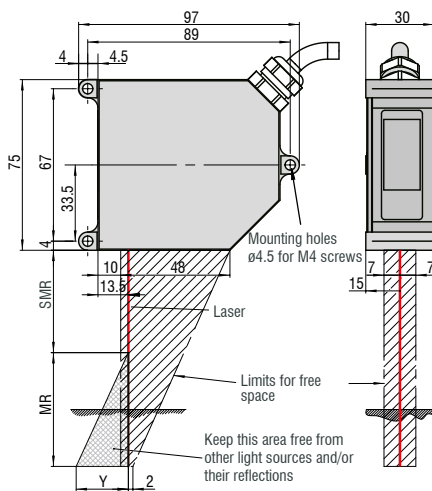

MR	SMR	Y
2	24	1.5
5	24	3.5
10	30	6.5
20	40	10.0
50	45	23.0
100	70	33.5

optoNCDT 2300-2 ... 2300-20
Direct reflection

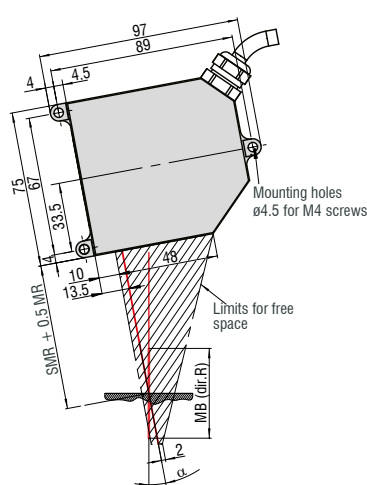

MR	SMR + 0.5 MR	α
2	25	20.5 °
5	26.5	20.5 °
10	35	17.5 °
20	50	13.8 °

optoNCDT 2300-200 /2300-300

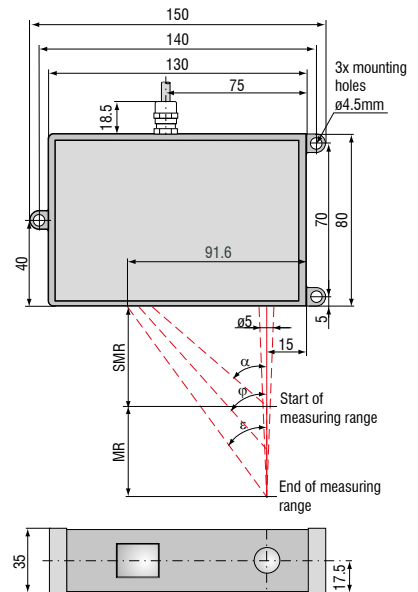

MR	α	φ	ε	A	B
200	25.1 °	16.7 °	13.1 °	91.6	76
300	18.3 °	12.2 °	9.6 °	99.4	81

Model		ILD2300-2	ILD2300-5	ILD2300-10	ILD2300-20	ILD2300-50	ILD2300-100	ILD2300-200	ILD2300-300
Measuring range ¹⁾		2 (2) mm	5 (2) mm	10 (5) mm	20 (10) mm	50 (25) mm	100 (50) mm	200 (100) mm	300 (150) mm
Start of measuring range	SMR	24 (24) mm	24 (24) mm	30 (35) mm	40 (50) mm	45 (70) mm	70 (120) mm	130 (230) mm	200 (350) mm
Midrange	MMR	25 (25) mm	26.5 (25) mm	35 (37.5) mm	50 (55) mm	70 (82.5) mm	120 (145) mm	230 (280) mm	350 (425) mm
End of measuring range	EMR	26 (26) mm	29 (26) mm	40 (40) mm	60 (60) mm	95 (95) mm	170 (170) mm	330 (330) mm	500 (500) mm
Linearity		≤ 0.6 μm	≤ 1.5 μm	≤ 2 μm	≤ 4 μm	≤ 10 μm	≤ 20 μm	≤ 60 μm	≤ 90 μm
		≤ 0.03 % FSO		≤ 0.02 % FSO		≤ 0.02 % FSO		≤ 0.03 % FSO	
Resolution (with 20 kHz)		0.03 μm	0.08 μm	0.15 μm	0.3 μm	0.8 μm	1.5 μm	3 μm	4.5 μm
		0.0015 % FSO							
Measuring rate		switchable (software) 49.14 / 30 / 20 / 10 / 5 / 2.5 / 1.5 kHz (49.14 kHz with reduced measuring range)							
Permissible ambient light		10,000 ... 40,000 lx							
Spot diameter	SMR	55 x 85 μm	70 x 80 μm	75 x 85 μm	140 x 200 μm	255 x 350 μm	350 μm	1300 μm	580 x 860 μm
	MMR	23 x 23 μm	30 x 30 μm	32 x 45 μm	46 x 45 μm	70 x 70 μm	130 μm	1300 μm	380 x 380 μm
	EMR	35 x 85 μm	70 x 80 μm	110 x 160 μm	140 x 200 μm	255 x 350 μm	350 μm	1300 μm	470 x 530 μm
Light source		laser diode (670 nm) class 2							
Protection class		IP65							
Operating temperature		0 ... +50 °C							
Storage temperature		-20 ... +70 °C							
Inputs/Outputs		Ethernet/EtherCAT RS422 analog output via C-Box							
Inputs		Laser on/off Sync/Trigger input							
Supply voltage		11 ... 30 V							
Power consumption		< 3 W (24 V)							
LED		status / power / Ethernet / EtherCAT							
Sensor cable	standard	0.25 m (with connector)							
	option	3 / 6 / 9 m with 15-pole sub-D connector							
Synchronization		possible for simultaneous or alternating measurements							
Electromagnetic compatibility (EMC)		EN 61326-1: 2006-10 DIN EN 55011: 2007-11 (group 1, class B) EN 61 000-6-2: 2006-03							
Vibration		2 g / 20 ... 500 Hz							
Shock		15 g / 6 ms / 3 axes							

FSO = Full Scale Output; The specified data apply to a white, diffuse reflecting surface (reference: ceramics)

SMR = start of measuring range; MMR = midrange; EMR = end of measuring range

¹⁾ Range specifications: value in brackets is valid for a measuring rate of 49.14 kHz

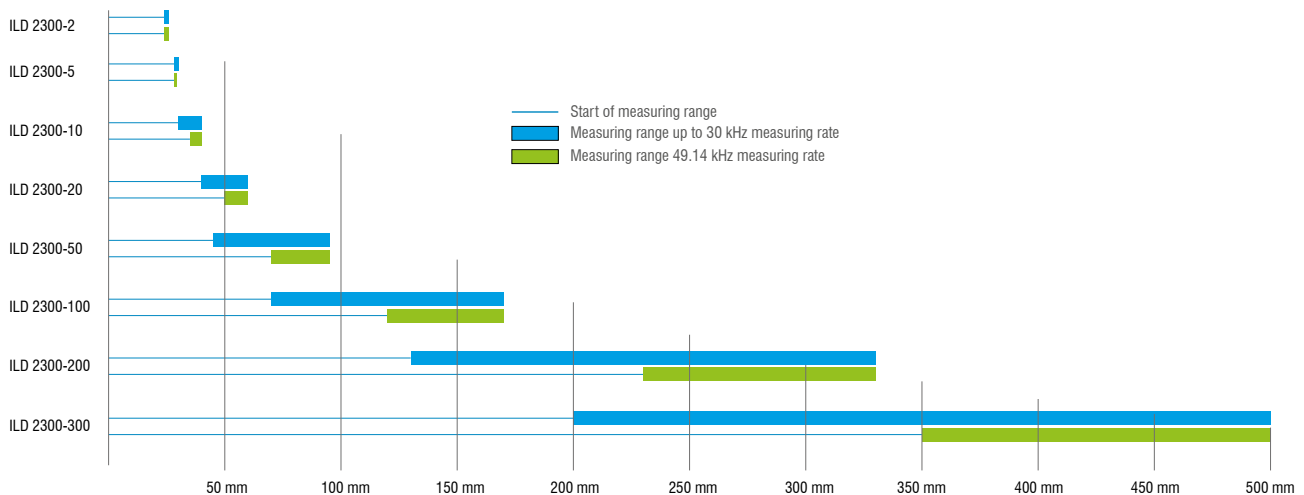

Accessories for all optoNCDT Series**Power supply**

- PS 2020 (power supply 24 V / 2.5 A, input 100 - 240 V AC, output 24 VDC / 2.5 A, mounting onto symmetrical standard rail 35 mm x 7.5 mm, DIN 50022)

Controller unit for evaluation and signal conversion

- C-Box/2A (controller for conversion and evaluation of up to 2 sensor signals)

Interface card

- IF2008 (interface card for multiple signal processing; analog and digital interfaces)

USB converter

- IF2001/USB RS422/USB converter (converter for digital signals in USB)

USB converter

- IF2004/USB 4-channel RS422/USB converter (converter for up to 4 digital signals in USB)

Accessories for optoNCDT 1320 / 1420 / 1402CL1**Supply and output cable (drag-chain suitable)**

- PCF1420-1/I (1 m, output 4...20 mA)
- PCF1420-1/I(O1) (1 m, output 4...20 mA)
- PCF1420-3/I (3 m, output 4...20 mA)
- PCF1420-6/I (6 m, output 4...20 mA)
- PCF1420-10/I (10 m, output 4...20 mA)
- PCF1420-15/I (15 m, output 4...20 mA)
- PCF1420-3/U (3 m, with integrated resistor, output 1...5 VDC)*
- PCF1420-6/U (6 m, with integrated resistor, output 1...5V DC)*
- PCF1420-10/U (10 m, with integrated resistor, output 1...5 VDC)*
- PCF1420-15/U (15 m, with integrated resistor, output 1...5 VDC)*
- PCF1420-3/IF2008 (3 m, interface and supply cable)
- PC1420-6/IF2008 (6 m, supply and output cable)
- PCF1420-10/IF2008 (10 m, interface and supply cable)

* on request with output 2...10 VDC

Supply and output cable, suitable for use with robots

(available in 90° version)

- PCR 1402-3/I (3 m)
- PCR 1402-6/I (6 m)
- PCR 1402-8/I (8 m)

Accessories for optoNCDT 1610 / 1630**Supply and output cable**

- PC 1605-3 (3 m)
- PC 1605-6 (6 m)
- PC 1607-5/BNC (5 m, BNC connector)

Accessories for optoNCDT 1750 / 1750LL / 1700BL**Supply and output cable (drag-chain suitable)**

- PC 1700-3 (3 m)
- PC 1700-10 (10 m)
- PC 1700-10/IF2008 (10 m, for use with interface card IF2008)
- PC 1700-3/T (3 m, for use with trigger box)
- PC 1700-10/T (10 m, for use with trigger box)
- PC 1700-3/USB (3 m, with USB-RS422-converter, power supply 90 ... 230 V AC)

Supply and output cable (suitable for use with robots)

- PCR 1700-5 (5 m)
- PCR 1700-10 (10 m)

Supply and output cables for temperatures up to 200 °C

- PC1700-3/OE/HT (3 m)
- PC1700-6/OE/HT (6 m)
- PC1700-15/OE/HT (15 m)

Protection housing

- SGH model (sizes S and M)
- SGHF model (sizes S and M)
- SGHF-HT model

Accessories for optoNCDT 2300 / 2300LL / 2300BL**Supply and output cable**

- PC2300-0,5Y (connection cable to PC or PLC; for operation a PC2300-3/SUB-D will be required)
- PC2300-3/SUB-D (3 m; for operation a PC2300-0,5Y will be required)
- PC 2300-3/IF2008 (interface and supply cable)
- PC 2300-3/OE (3 m)
- PC 2300-6/OE (6 m)
- PC 2300-9/OE (9 m)
- PC 2300-15/OE (15 m)

* other cable lengths on request

Protection housing

- SGH model (sizes S and M)
- SGHF model (sizes S and M)
- SGHF-HT model

Supply and output cables for temperatures up to 200 °C

- PC2300-3/OE/HT (3 m)
- PC2300-6/OE/HT (6 m)
- PC2300-9/OE/HT (9 m)
- PC2300-15/OE/HT (15 m)

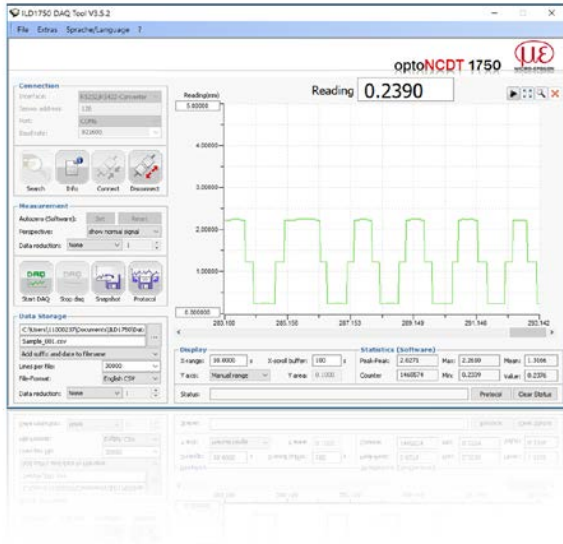

optoNCDT Demo Tool

The scope of supply includes a software for easy sensor configuration. The settings can be implemented conveniently via a Windows user interface on the PC. The sensor parameters are sent to the sensor via the serial port and can also be saved if required. The software is available as single and multi-channel version. The sensor is connected to the PC via the sensor cable using a USB converter.

Free download

Download free of charge from www.micro-epsilon.com/download: software, driver and well-documented driver DLL for easy sensor integration in existing or customer software.

Protection housing for harsh environment

To protect the laser sensors in extreme environments, individual protective housings are available for all sensor models. There are three different models:

SGH model:

Completely enclosed housing with an integrated front window, where the sensor measures through the window. The water-resistant housing provides protection against solvents and detergents.

SGHF model:

With window and compressed-air connection ideal for high ambient temperatures. The integrated air cooling of the housing offers optimum protection for the sensor.

SGHF-HT model

This water-cooled protection housing with window and compressed-air connection is designed for measurement tasks in ambient temperatures up to 200 °C.

Suitable for all long-range sensors

optoNCDT 1710

optoNCDT 1750-500 and optoNCDT 1750-750

optoNCDT 2310

optoNCDT 2300 - 200

Maximum ambient temperature 200 °C

Maximum cooling water temperature $T(max) = 10\text{ °C}$

Minimum water flow rate $Q(min) = 3\text{ liters/min}$



SGHx IL D size S (140x140x71mm)
for optoNCDT 1750 / 2300 dimensions 97 x 75 mm

SGHx IL D size M (140x180x71mm)
for optoNCDT 1750 / 2300 dimensions 150 x 80 mm



IF2008 - PCI interface card

The IF2008 interface card is designed for installation in PCs and enables the synchronous capture of four digital sensor signals and two encoders. The IF2008E expansion board enables the acquisition of two digital sensor signals, two analog sensor signals and eight I/O signals. The absolutely synchronous data acquisition plays an important role particularly for planarity or thickness measurement tasks. The data are stored in a FIFO memory in order to enable resource-saving processing in the PC in blocks.

Special features

- 4x digital signals and 2x encoders with IF2008 basic PCB
- 2x digital signals, 2x analog signals and 8x I/O signals with IF2008E expansion board
- Additional expansion board for a total of 6x digital signals, 2x encoders, 2x analog signals and 8x I/O signals
- FIFO data memory
- Synchronous data acquisition

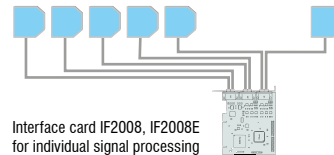

Interface card IF2008, IF2008E
for individual signal processing

IF2001/USB converter RS422 to USB

The RS422/USB converter transforms digital signals from a laser-optical sensor into a USB data packet. The sensor and the converter are connected via the RS422 interface of the converter. Data output is done via USB interface. The converter loops through further signals and features such as laser on/off, switch signals and function output. The connected sensors and the converter can be programmed through software.



IF2004/USB: 4-channel converter from RS422 to USB

The RS422/USB converter is used for transforming digital signals from up to four optical sensors into USB data signals. The converter has four trigger inputs and a trigger output for connecting additional converters. Data is output via an USB interface. The connected sensors and the converter can be programmed through software.

Special features

- 4x digital signals via RS422
- 4x trigger inputs, 1x trigger output
- Synchronous data acquisition
- Data output via USB



C-Box/2A controller for conversion and evaluation of up to two sensor signals

C-Box/2A is used for fast D/A conversion of two digital input signals or for evaluating two digital sensor signals. The controller is compatible with the optoNCDT 2300 laser triangulation sensors. Output of the sensor signals is possible via two configurable analog outputs, Ethernet or USB. Handling of the C-Box/2A and of the connected sensors are performed via web interface. Averaging functions, thickness, diameter, step and inclinations can be calculated. The D/A conversion is executed at 16Bit and max. 70kHz.



High performance sensors made by Micro-Epsilon



Sensors and systems for displacement and position



Sensors and measurement devices for non-contact temperature measurement



2D/3D profile sensors (laser scanner)



Optical micrometers, fiber optic sensors and fiber optics



Color recognition sensors, LED analyzers and color inline spectrometer

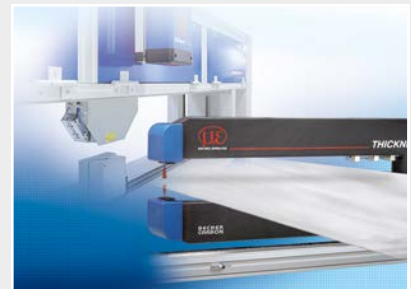

Measurement and inspection systems