



# More Precision

**thermoMETER** // Non-contact IR temperature sensors





### thermoMETER CSLaser

Miniature IR sensor with integrated controller and laser sighting

- Measuring range from -30°C to 1600°C, measuring fields from 0.5mm and response times from 10ms
- Optical resolution up to 300:1 with selectable focus settings
- Double laser sighting with 2 rays for exact measuring field marking and focusing
- Scalable 4-20mA two-wire analog output and simultaneous alarm output
- Optional USB programming interface and programming software
- Emissivity directly adjustable via rotary controller or software
- Protection against short circuit and polarity change
- Up to 85°C ambient temperature without cooling
- Automatic laser switch-off at 50°C
- Extensive supply voltage range: 5 - 28VDC

#### Optical specifications thermoMETER CSLaser

□ = smallest spot size (mm)

Standard Focus															
2H SF	300:1	20	17.8	15.5	13.2	11	8.6	6.4	4.8	3.7	5.5	8.6	11.8	17	26.6
2L SF	150:1	20	18.3	16.5	14.8	13	11.4	9.6	8.5	7.3	9.8	13.5	17.3	23.5	34.6
distance (mm)		0	150	300	450	600	750	900	1000	1100	1200	1350	1500	1750	2200
Close Focus															
2H CF2	300:1	20	13.5	7	0.5	7.3	14	21	n.v.	34.5	n.v.	48.2	61.8	75.4	89
2L CF2	150:1	20	13.7	7.3	1	8	15	22	n.v.	36	n.v.	50	64	78	92
2H CF3	300:1	20	15.2	10.3	5.5	0.7	5.8	11	n.v.	21.2	n.v.	31.5	41.8	52.1	62.4
2L CF3	150:1	20	15.4	10.7	6	1.3	6.7	12	n.v.	22.6	n.v.	33.3	44	55	65
2H CF4	300:1	20	18	16	13.8	11.8	9.7	7.6	5.6	3.5	1.5	3.8	8.6	13.3	18
2L CF4	150:1	20	18.1	16.3	14.4	12.5	10.6	8.7	6.8	4.9	3	5.6	10.7	12.8	21
distance (mm)		0	50	100	150	200	250	300	350	400	450	500	600	700	800
Far Focus															
2H FF	300:1	20	19	18	17	16	15	14	13.4	12	16.5	24.4	33.4	40	
2L FF	150:1	20	20.5	21	21.5	22	22.5	23	23.4	24	29	41	53.4	62.5	
distance (mm)		0	450	900	1350	1800	2250	2700	3000	3600	4000	5000	6000	6750	

Model	CSL-SF50	CSLHS-SF50	CSLM-2LSF150	CSLM-2HSF300
Optical resolution	50:1		150:1	300:1
Temperature range <sup>1</sup>	-30°C to 1000°C	-20°C to 150°C	250°C to 800°C	385°C to 1600°C
Spectral range	8 to 14µm		1.6µm	
System accuracy <sup>3</sup>	±1% or ±1°C		±(0.3% of reading + 2°C) <sup>4</sup>	
Repeatability <sup>3</sup>	±0.5% or ±0.5°C		±(0.1% of reading + 1°C) <sup>4</sup>	
Temperature resolution	0.1°C	0.025°C	0.1°C	
Response time (90% signal)	150ms		10ms	
Emissivity/gain <sup>1</sup>	0.100 to 1.100			
IR window correction <sup>2</sup>	0.100 to 1.100			
Signal processing <sup>2</sup>	peak hold, valley hold, average; extended hold function with threshold and hysteresis			
Outputs/analog	4 to 20mA			
Output/alarms	0 to 30V / 500mA (open collector)			
Outputs/digital (optional)	mono-/bidirectional, 9.6kBaud, 0/3V level, USB			
Output/impedance	max. 1000Ω (depends on power supply)			
Power consumption (only laser)	45mA at 5V / 20mA at 12V / 12mA at 24V			
Power supply	5 to 28VDC			
Laser	class II (635nm), 1mW, ON/OFF via software			
Protection class	IP65 (NEMA-4)			
Ambient temperature	-20°C to 85°C (50°C if Laser ON)			
Storage temperature	-40°C to 85°C			
Relative humidity	10 to 95%, non condensing			
Vibration	IEC 68-2-6: 3 G, 11 to 200Hz, any axis			
Shock	IEC 68-2-27: 50 G, 11ms, any axis			
Weight	600g			

<sup>1</sup> adjustable via sensor and software

<sup>2</sup> adjustable via software

<sup>3</sup> at ambient temperature 23 ±5°C; whichever is greater; with object temperature ≥ 0°C

<sup>4</sup> ε = 1, response time 1s

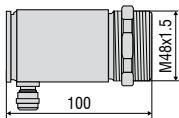

**Product identification**

CSL -	SF50
	Focus [SF50 / CF1 / CF2 / CF3 / CF4]
	thermoMETER CSLaser

**Product identification**

CSLM -	2	H	SF300
			Focus [SF300 / CF1 / CF2 / CF3 / CF4]
			Temperature range [H]
			Spectral range [1.6µm]
			thermoMETER CTLaserFAST

**Optical specifications thermoMETER CSLaser CSL-SF50 and CSLHS-SF50**

□ = smallest spot size (mm)

Standard Focus																
SF50 lens	50:1	20	20.5	21	21.5	22	22.5	23	23.5	24	29.5	35	48	57	68	
distance (mm)	0	150	300	450	600	750	900	1050	1200	1350	1500	1800	2100	2400		
Close Focus																
CF1 lens	50:1	20	10	8.5	1.4	11	26	41	57	72	88	103	118	133	164	225
CF2 lens	50:1	20	15.5	15	12	9	3	11	19	26	33	42	49	57	72	103
CF3 lens	50:1	20	16.5	16	14	12	8	4	10	16	21	28	33	40	64	76
CF4 lens	50:1	20	19.5	19	18.4	18	16.5	15	14	13	11.5	10	9	12	25	32
distance (mm)	0	40	50	70	100	150	200	250	300	350	400	450	500	600	700	800

**Accessories page 54-55**

- Mounting bracket
- Air purge collar
- Rail mount adapter for controller
- Water cooled housing
- Certificate of calibration
- USB kit (TM-USBK-CS) p.55



**LASER LIGHT**  
DO NOT STARE INTO BEAM  
CLASS 2 LASER  
IEC 60825-1:2007  
1mW / 630-650nm

**CSLaser**

sensor

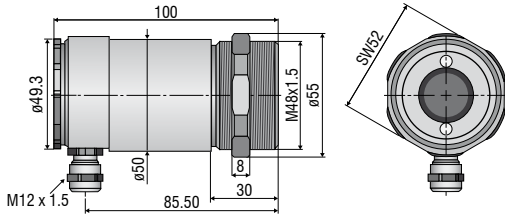

**CS**

sensor with integrated controller

ancillary CF lens (optional)

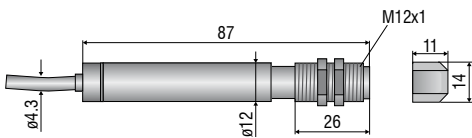

**CSmicro / CSmicro 2W**

ancillary CF lens (optional)

sensor

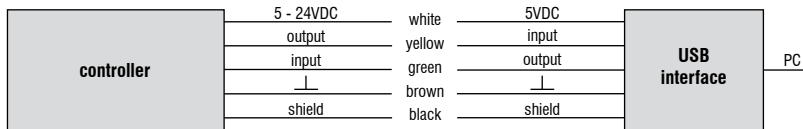
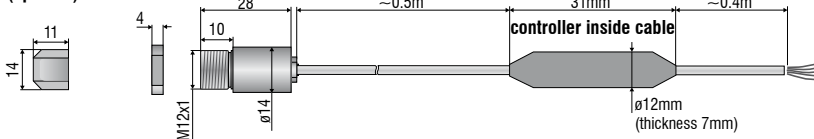

**CX**

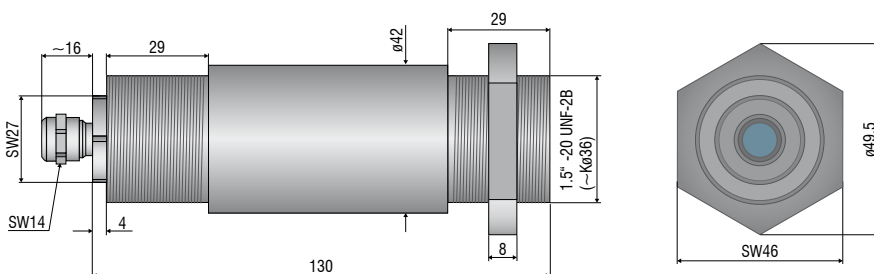

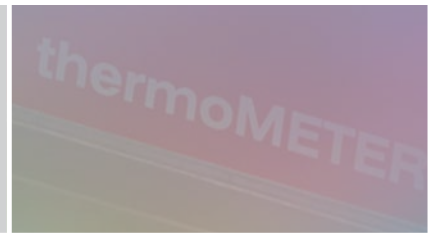

**Mechanical accessories CS / CSmicro / CSmicro 2W**

Art. No.	Model	Description
2970279	TM-FB-CS	Mounting bracket, fixed
2970280	TM-AB-CS	Mounting bracket, adjustable
2970281	TM-MB-CS	Mounting bolts with M12x1 thread
2970282	TM-MG-CS	Mounting fork, adjustable in 2 axes, with M12x1 fastening
2970283	TM-AP-CS	Air purge collar for 10:1 sensors
2970284	TM-APL-CS	Air purge collar, laminar
2970285	TM-APLCF-CS	Air purge collar, laminar, with integrated ancillary CF lens
2970286	TM-RAM-CS	Right angle mirror for measurements 90° to the sensor axis
2970287	TM-USBK-CS	USB kit: USB programming adapter, software CompactConnect

**Optical accessories CS / CSmicro / CSmicro 2W**

2970277	TM-CF-CS	Ancillary CF lens for CS models
2970278	TM-PW-CS	Protective window for CS models

**Calibration CS / CSmicro / CSmicro 2W**

2970288	TM-CERT-CS	Certificate of calibration
---------	------------	----------------------------

**Mechanical accessories CX**

Art. No.	Model	Description
2970307	TM-AP-CX	Air purge collar, aluminum (anodized)
2970321	TM-FB-CX	Mounting bracket, adjustable in one axis, stainless steel
2970322	TM-AB-CX	Mounting bracket, adjustable, in 2 axes, stainless steel
2970311	TM-USBK-CX	USB kit: USB programming adapter, software CompactConnect

**Optical accessories CX**

2970302	TM-CF-CX	Ancillary CF lens for CX models
2970303	TM-PW-CX	Protective window for CX models

**Calibration CX**

2970323	TM-CERT-CX	Certificate of calibration
---------	------------	----------------------------

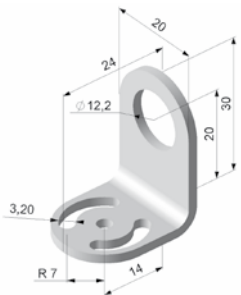

TM-FB-CS Mounting bracket, fixed



TM-MG-CS Mounting fork with M12x1 thread, adjustable in two axes

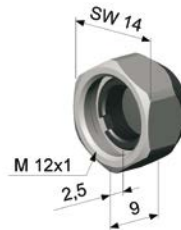

TM-CF-CS Ancillary CF lens (only for LT models)

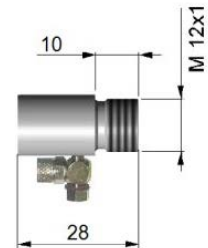

TM-AP-CS Air purge collar for 10:1 sensors

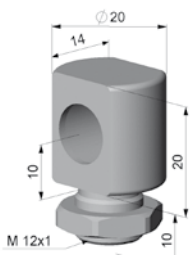

TM-MB-CS Mounting bolts with M12x1 thread adjustable in one axis

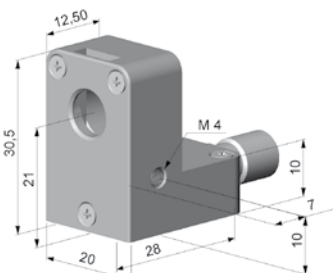

TM-APL-CS Air purge collar, laminar

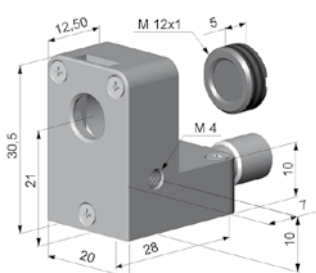

TM-APLCF-CS Air purge collar, laminar with integrated ancillary CF lens



TM-APL-CS Air purge collar, laminar  
TM-MG-CS mounting fork



TM-AP-CX Air purge collar for CX sensors

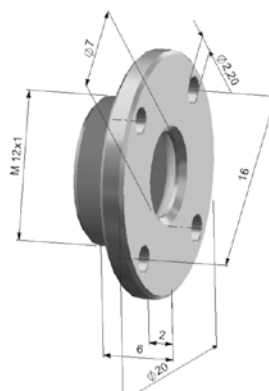

TM-CF-CX Ancillary CF lens, TM-PW-CX protective window

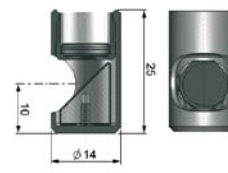

TM-RAM-CS Right angle mirror

## Further IR temperature measurement devices from Micro-Epsilon



**thermoIMAGER TIM**  
Compact USB thermal imaging cameras  
for precise thermography



**thermoMETER CTVideo/CSVideo**  
IR temperature sensors with crosshair laser  
sighting and video output



**thermoMETER Handheld**  
Innovative handheld pyrometer with laser  
sighting for inspection and maintenance