



# More Precision

**thermoMETER** // Non-contact IR temperature sensors





### thermoMETER CTLaser / CTLaserFAST

Innovative infrared temperature sensor with laser sighting

- Measuring range from -50°C to 975°C
- thermoMETER CTLaserFAST with response times of just 9ms
- Smallest spots from 0.9mm - even with low object temperatures
- Double laser sighting for exact measuring field marking and focusing
- Optical system 75:1 with selectable focus settings
- Separate controller with programming keys backlit display
- Up to 85°C ambient temperature without cooling
- Automatic laser switch-off at 50°C
- Selectable and scalable analog output, optional digital interfaces

#### Optical specifications thermoMETER CTLaser

□ = smallest spot size (mm)

##### Standard Focus

SF75 lens	75:1	20	19.5	19	18.5	18	17.5	17	16.5	16	20.5	25	34	43	52		
distance (mm)		0	150	300	450	600	750	900	1050	1200	1350	1500	1800	2100	2400		

##### Close Focus

CF1 lens	75:1	20	9	5	0.9	10	25	40	55	70	85	100	115	130	160	190	220
CF2 lens	75:1	20	16	14	11	8	1.9	9	16.5	24	31	38	45.5	53	68	82	97
CF3 lens	75:1	20	17	16	14	11	7	2.75	8.5	14	19.5	25.5	31	37	48	60	71
CF4 lens	75:1	20	19	18.5	18	17	15.5	14	12.5	11	9	7.5	5.9	9	15	20	26
distance (mm)		0	40	50	70	100	150	200	250	300	350	400	450	500	600	700	800

#### Optical specifications thermoMETER CTLaserFAST

□ = smallest spot size (mm)

##### Standard Focus

SF50 lens	50:1	20	20.5	21	21.5	22	22.5	23	23.5	24	29.5	35	48	57	68		
distance (mm)		0	150	300	450	600	750	900	1050	1200	1350	1500	1800	2100	2400		

##### Close Focus

CF1 lens	50:1	20	10	8.5	1.4	11	26	41	57	72	60	103	118	133	164	194	225
CF2 lens	50:1	20	15.5	15	12	9	3	11	19	26	33	42	49	57	72	88	103
CF3 lens	50:1	20	16.5	16	14	12	8	4	10	16	21	28	33	40	52	64	76
CF4 lens	50:1	20	19.5	19	18.4	18	16.5	15	14	13	11.5	10	9	12	19	25	32
distance (mm)		0	40	50	70	100	150	200	250	300	350	400	450	500	600	700	800

Model	CTL-SF75-C3	CTLF-SF50-C3
Optical resolution	75:1	50:1
Temperature range <sup>1</sup>	-50°C to 975°C	
Spectral range	8 to 14µm	
System accuracy <sup>2,3</sup>	±1% or ±1°C	±1.5% or ±1.5°C
Repeatability <sup>2</sup>	±0.5% or ±0.5°C	±1% or ±1°C
Temperature resolution	0.1°C	0.5°C
Response time (90% signal)	120ms	9ms
Emissivity/gain <sup>1</sup>	0.100 to 1,100	
Transmissivity <sup>1</sup>	0.100 to 1,000	
Signal processing <sup>1</sup>	peak hold, valley hold, average; extended hold function with threshold and hysteresis	
Certificate of calibration	optional	
Outputs/analog	channel 1	0/4 to 20mA, 0 to 5/10V, thermocouple J, K
	channel 2	sensor temperature (-20 to 180°C as 0 to 5V or 0 to 10V), alarm output
Outputs/analog	optional	relay: 2 x 60VDC/42VAC <sub>eff</sub> ; 0.4A; electrically isolated
Alarm output		open - collector (24V/ 50mA)
Outputs/digital	optional	USB, RS232, RS485, CAN, Profibus DP, Ethernet
Output impedances	current output	mA max. 500Ω (with 5 to 36VDC)
	voltage output	mV min. 100kΩ load impedance; thermocouple 20Ω
Inputs	programmable functional inputs for external emissivity adjustment, ambient temperature compensation, trigger (reset of hold functions)	
Cable length	3m (standard), 8m, 15m	
Power supply	8 to 36VDC; max. 160mA	
Laser	class II (635nm), 1mW, ON/OFF via controller or software	
Protection class	IP65 (NEMA-4)	
Ambient temperature	sensor: -20°C to 85°C (50°C with Laser ON) controller: 0°C to 85°C	
Storage temperature	sensor: -40°C to 85°C controller: -40°C to 85°C	
Relative humidity	10 to 95%, non condensing	
Vibration	sensor	IEC 68-2-6: 3 G, 11 to 200Hz, any axis
Shock	sensor	IEC 68-2-27: 50 G, 11ms, any axis
Weight	sensor: 600g; controller: 420g	

<sup>1</sup> adjustable via programming keys or software

<sup>2</sup> at ambient temperature 23 ±5°C; whichever is greater

<sup>3</sup> temperature of the object >0°C

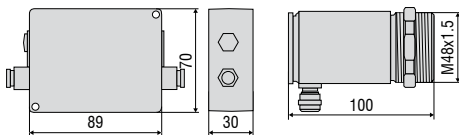

**Product identification**

CTL -	SF75-	C3
Cable length [3m (standard) / 8m / 15m]		
Focus [SF75 / CF / CF2 / CF3 / CF4]		
thermoMETER CTLaser		

**Product identification**

CTLF -	SF50-	C3
Cable length [3m (standard) / 8m / 15m]		
Focus [SF50 / CF1 / CF2 / CF3 / CF4]		
thermoMETER CTLaserFAST		

**Accessories page 20 - 21**

- Mounting bracket
- Air purge collar
- Rail mount adapter for controller

- Water cooled housing
- Interface kit
- Software CompactConnect
- Certificate of calibration



**LASER LIGHT**  
DO NOT STARE INTO BEAM  
CLASS 2 LASER  
IEC 60825-1:2007  
1mW / 630-650nm

CTLaser / CTLaserFAST / CTLaserGLASS / CTLaserM1/M2/M3/M5 / CTLaserCOMBUSTION

Controller

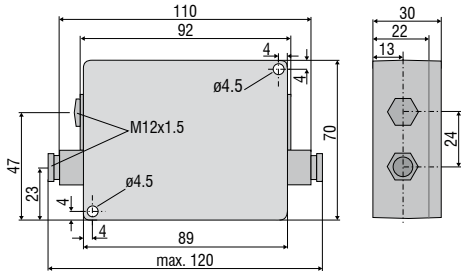

Sensor

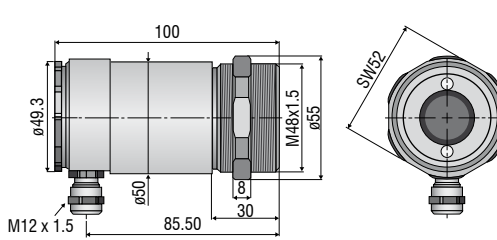

CTratioM1

Controller

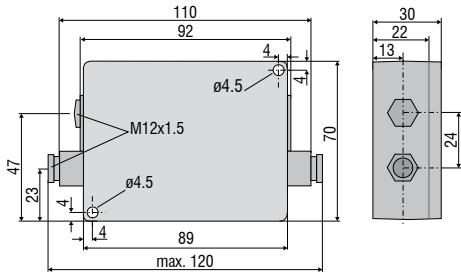

Sensor

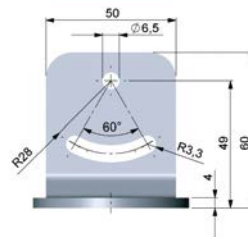
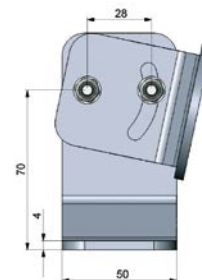
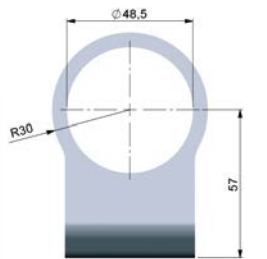
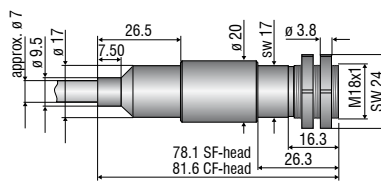

TM-FB-CTL Mounting bracket (fixed); included in CTL scope of supply

TM-AB-CTL Mounting bracket (adjustable)



TM-W-CTL Water cooled housing and air purge collar TM-AP-CTL, mounted on adjustable mounting bracket TM-AB-CTL

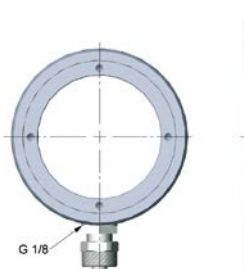

TM-W-CTL Water cooled housing

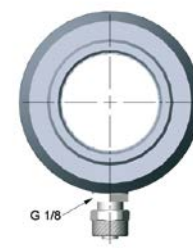
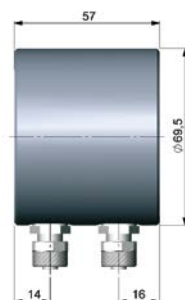

TM-AP-CTL Air purge collar

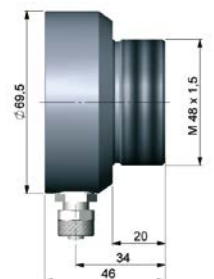

Mechanical accessories		
Art. No.	Model	
2970238	TM-AB-CTL	Mounting bracket, adjustable, stainless steel
2970239	TM-AP-CTL	Air purge collar, stainless steel
2970240	TM-W-CTL	Water cooled housing, stainless steel, for ambient temperatures up to 175°C
2970241	TM-RAIL-CTL	Rail mount adapter for CTLaser controller
2970242	TM-COV-CTL	Closed cover for controller
2970243	TM-MN-CTL	Mounting nut, stainless steel (spare)
2970244	TM-FB-CTL	Mounting bracket, fixed, stainless steel (spare)
2970298	TM-A20UN-CTL	Screw adapter M48x1 on 20UN-2A screw including mounting nut

High temperature accessories for CTLaser		
2970366	TM-J-CTL	Cooling jacket (length 228mm, ø89mm) (conversion kit TM-CONK-CTL is required)
2970374	TM-CONK-CTL	Conversion kit for CTL on axial cable exit, for integration in cooling jacket
2970368	TM-JAB-CTL	Adjustable mounting bracket for cooling jacket
2970369	TM-MF-CTL	Mounting flange M48x1.5 for TM-PF-CTL
2970370	TM-AST300-CTL	Reflection protection tube M48x1.5, 300mm length
2970371	TM-PA-CTL	Pipe adapter M48x1.5
2970372	TM-RM-CTL	Furnace wall mount accessory for CTL (TM-MF-CTL, TM-AST300-CTL and TM-PA-CTL)
2970412	TM-PF-CTL	Pipe flange M48x1.5 for directly mounting a CTL sensor
2970487	TM-CJA-CTL	Cooling Jacket Advanced - universal cooling jacket for CSLaser, CTLaser and CTVideo / CSVideo up to 315°C

Calibration		
2970253	TM-CERT-CTL	Certificate of calibration
2970324	TM-HTCERT-CTL	Certificate of calibration for CTLaser M1-/M2-/M3-/M5-/G-sensors

Interfaces		
2970245	TM-USBK-CTL	USB interface, computer cable, software CompactConnect second cable gland for controller
2970246	TM-RS232K-CTL	RS232 interface, computer cable, software CompactConnect second cable gland for controller
2970338	TM-RS485USBK-CTL	RS485-USB-adapter, incl. PC cable, Software CompactConnect and CTmulti, second cable gland for use with interface board TM-RS485B-CTL
2970248	TM-RS485B-CTL	RS485 interface board incl. second cable gland
2970249	TM-CANK-CTL	CAN-Bus interface; protocol: CANopen Presettings: module address20 (14H), 250kBaud, 0-60°C
2970250	TM-PFBDPK-CTL	Profibus-DPV1 interface for CT selectable with DIN M12 or SUB-D connection
2970251	TM-ETHNK-CTL	Ethernet-Kit: interface board, external Ethernet adapter, software CompactConnect, second cable gland
2970252	TM-RI-CTL	Relay interface: two electrically isolated relays, 60VDC/ 42VAC <sub>eff</sub> 0.4A

Sensor cables and high temperature cables for CTLaser		
2970374	TM-CONK-CTL	Connector-Kit for cables with connector
4800254.003	TM-CB3C-CTL	Sensor cable with connector (3m)
4800254.003H	TM-CB3HC-CTL	High-temperature sensor cable with adapter (3m)
4800254.008	TM-CB8C-CTL	Sensor cable with adapter (8m)
4800254.008H	TM-CB8HC-CTL	High-temperature sensor cable with adapter (8m)
4800254.015	TM-CB15C-CTL	Sensor cable with adapter (15m)
4800254.015H	TM-CB15HC-CTL	High-temperature sensor cable with adapter (15m)



TM-J-CTL cooling jacket (length 228mm, ø 89mm) with adjustable mounting bracket TM-JAB-CTL; suitable for ambient temperatures up to 180°C

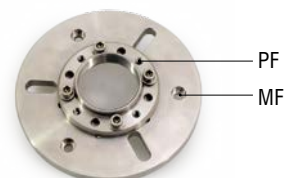

TM-PF-CTL and TM-MF-CTL mounting flange M48x1,5 for directly mounting a CTL sensor



TM-RM-CTL Furnace wall mount accessory for CTLaser / CTratio: TM-MF-CTL, TM-PF-CTL, TM-AST300-CTL and TM-PA-CTL

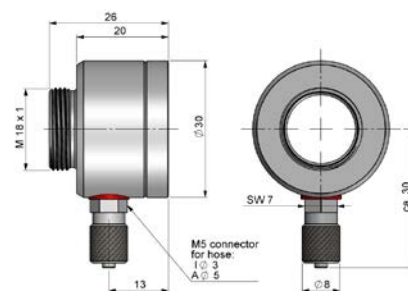

TM-AP-CTR Air purge collar

CTratio		
Art. No.	Model	
2970348	TM-FB-CTR	Mounting bracket, stainless steel, adjustable in one axis
2970395	TM-AP-CTR	Air purge collar, stainless steel
2970373	TM-RM-CTR	Furnace wall mount, stainless steel
2970351	TM-CERT-CTR	Certificate of calibration

## Further IR temperature measurement devices from Micro-Epsilon



**thermoIMAGER TIM**  
Compact USB thermal imaging cameras  
for precise thermography



**thermoMETER CTVideo/CSVVideo**  
IR temperature sensors with crosshair laser  
sighting and video output



**thermoMETER Handheld**  
Innovative handheld pyrometer with laser  
sighting for inspection and maintenance