



More Precision

thermoMETER // Non-contact infrared temperature sensors





thermoMETER CTLaserCOMBUSTION

Non-contact IR temperature sensor with laser sighting for measurements through flames and of flame gases in combustion processes from 200°C to 1450°C (optional up to 1650°C). The CTLC-4 is ideally suitable to monitor workpieces inside ovens, to measure inside chemical reactors and to inspect the brick temperature in combustion chambers.

- Measuring range 200°C to 1450°C
- Double laser marks exact spot size from 1.6mm
- Usable in all modern applications where "size of spot matters"
- Optical system 45:1 with selectable focus
- Up to 85°C ambient temperature without cooling
- Automatic laser switch-off at 50°C
- Cooling and protection accessories for harsh environmental conditions

Optical specifications thermoMETER CTLasercombustion

□ = smallest spot size / focal point (mm)

Standard Focus

SF45 lens	45:1	20	20.8	21.7	22.5	23.4	24.2	25	25.9	26.7	32.5	38.4	50.1	61.7	73.4		
distance in mm		0	150	300	450	600	750	900	1050	1200	1350	1500	1800	2100	2400		

Close Focus

CF1 lens	45:1	20	9.5	6.9	1.6	10.9	26.3	41.7	57.1	72.6	88	103.4	118.9	134.3	165.1	196	226.9
CF2 lens	45:1	20	15.6	14.5	12.3	8.9	3.4	11.2	19	26.8	34.6	42.4	50.2	58	73.6	89.2	104.8
CF3 lens	45:1	20	16.9	16.1	14.6	12.3	8.4	4.5	10.6	16.8	22.9	29	35.1	41.3	53.5	65.8	78
CF4 lens	45:1	20	19.1	18.9	18.4	17.8	16.7	15.6	14.4	13.3	12.2	11.1	10	13.3	20	26.7	33.3
distance in mm		0	40	50	70	100	150	200	250	300	350	400	450	500	600	700	800

Model	CTLC-4SF45-C3	CTLC-2SF45-C3	CTLC-6SF45-C3
Optical resolution	45:1	45:1	45:1
Temperature range ¹	200°C to 1450°C (optional 400°C to 1650°C)		
Spectral range	3.9µm	4.24µm	4.64µm
Fields of application	through flames to monitor workpieces inside ovens, to measure inside chemical reactors, to observe the brick temperature in combustion chambers	CO ₂ flame gases in combustion processes, garbage burning or processes inside chemical reactors	CO flame gases in combustion processes, garbage burning or processes inside chemical reactors
System accuracy ^{3,4}	± 1%		
Repeatability ³	± 0.5% or ± 0.5°C		
Temperature resolution (digital)	0.1°C		
Response time (90% signal) ²	10ms		
Emissivity/gain ¹	0.100 to 1.100		
Transmissivity/gain ¹	0.100 to 1.000		
Signal processing ¹	peak hold, valley hold, average; extended hold function with threshold and hysteresis		
Outputs/analog	channel 1	0/4 to 20mA, 0 to 5/10V; thermocouple J, K	
	channel 2	sensor temperature (-20°C to 180°C as 0 to 5V/10V), alarm output	
Alarm output	open collector (24V / 50A)		
Optional	relays: 2 x 60VDC/42 VAC _{eff} ; 0.4A; electrically isolated		
Outputs/digital	optional	USB, RS232, RS485, CAN, Profibus DP, Ethernet	
Output impedances	current output	mA max. 500Ω (with 8 to 36VDC)	
	voltage output	mV min. 100kΩ load impedance, thermocouple 20Ω	
Inputs	programmable functional inputs for external emissivity adjustment, ambient temperature compensation, trigger		
Cable length	3m (standard), 8m, 15m		
Power supply	8 to 36VDC; max. 160mA		
Laser	class II (635nm), 1mW, ON/OFF via controller or software		
Protection class	IP65 (NEMA-4)		
Ambient temperature	sensor: -20°C to 85°C (50°C if Laser ON); controller: 0°C to 85°C		
Storage temperature	-40°C to 85°C		
Relative humidity	10 to 95%, non-condensing		
Vibration	IEC 68-2-6: 3 G, 11 to 200Hz, any axis		
Shock	IEC 68-2-27: 50 G, 11ms, any axis		
Weight	sensor: 600g; controller: 420g		

¹ adjustable via programming keys or software

² with dynamic adaption at low signal levels

³ ambient temperature 23±5°C; whichever is greater; object temperature ≥ 0°C

⁴ ε = 1, response time 1s

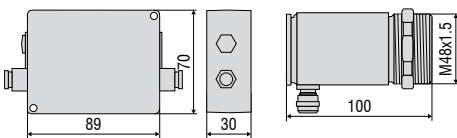

Product identification

CTLC -	4	SF45-	C3
Cable length [3m (standard) / 8m / 15m]			
Focus [SF45 / CF1 / CF2 / CF3 / CF4]			
Spectral range [4 = 3.9µm / 2 = 4.24µm / 6 = 4.64µm]			
thermoMETER CTLaserCOMBUSTION			

Accessories page 20 - 21

- Mounting bracket
- Air purge collar
- Rail mount adapter for controller
- Water cooled housing
- Interface kit
- Certificate of calibration



LASER LIGHT
DO NOT STARE INTO BEAM
CLASS 2 LASER
DIN EN 60825-1:2007
1mW / 630-650nm

Mechanical accessories		
Art. No.	Model	
2970238	TM-AB-CTL	Mounting bracket, adjustable, stainless steel
2970239	TM-AP-CTL	Air purge collar, stainless steel
2970240	TM-W-CTL	Water cooled housing, stainless steel, for ambient temperatures up to 175°C
2970241	TM-RAIL-CTL	Rail mount adapter for CTLaser controller
2970242	TM-COV-CTL	Closed cover for controller
2970243	TM-MN-CTL	Mounting nut, stainless steel (spare)
2970244	TM-FB-CTL	Mounting bracket, fixed, stainless steel (spare)
2970298	TM-A20UN-CTL	Screw adapter M48x1.5 on 20UN-2A screw including mounting nut

High temperature accessories		
2970366	TM-J-CTL	Cooling jacket (length 228mm, ø89mm) (conversion kit TM-CONK-CTL is required)
2970374	TM-CONK-CTL	Conversion kit for CTL on axial cable exit, for integration in cooling jacket
2970368	TM-JAB-CTL	Adjustable mounting bracket for cooling jacket
2970369	TM-MF-CTL	Mounting flange M48x1.5 for TM-PF-CTL
2970370	TM-AST300-CTL	Reflection protection tube M48x1.5, 300mm length
2970371	TM-PA-CTL	Pipe adapter M48x1.5
2970372	TM-RM-CTL	Furnace wall mount accessory for CTL (TM-MF-CTL, TM-AST300-CTL and TM-PA-CTL)
2970412	TM-PF-CTL	Pipe flange M48x1.5 for directly mounting a CTL sensor
2970487	TM-CJA-CTL	Cooling Jacket Advanced - universal cooling jacket for CSLaser, CTLaser and CTVideo / CSVideo up to 315°C

Calibration		
2970253	TM-CERT-CTL	Certificate of calibration
2970324	TM-HTCERT-CTL	Certificate of calibration for CTLaser M1-/M2-/M3-/M5-/G-sensors

Interfaces		
2970245	TM-USBK-CTL	USB interface, computer cable, CompactConnect software second cable gland for controller
2970246	TM-RS232K-CTL	RS232 interface, computer cable, CompactConnect software, second cable gland for controller
2970338	TM-RS485USBK-CTL	RS485-USB-adapter, incl. PC cable, CompactConnect software and CTmulti, second cable gland for use with interface board TM-RS485B-CTL
2970248	TM-RS485B-CTL	RS485 interface board incl. second cable gland
2970249	TM-CANK-CTL	CAN-Bus interface; protocol: CANopen Presets: module address20 (14H), 250kbaud, 0-60°C
2970250	TM-PFBDPK-CTL	Profibus-DPV1 interface with plug-in connection
2970251	TM-ETHNK-CTL	Ethernet-Kit: interface board, external Ethernet adapter, CompactConnect software, second cable gland
2970252	TM-RI-CTL	Relay interface: two electrically isolated relays, 60VDC/ 42VAC _{eff} 0.4A

Sensor cables and high temperature cables for CTLaser		
2970374	TM-CONK-CTL	Connector-Kit for cables with connector
4800254.003	TM-CB3C-CTL	Sensor cable with connector (3m)
4800254.003H	TM-CB3HC-CTL	High-temperature sensor cable (up to 180°C) with connector (3m)
4800254.008	TM-CB8C-CTL	Sensor cable with connector (8m)
4800254.008H	TM-CB8HC-CTL	High-temperature sensor cable (up to 180°C) with connector (8m)
4800254.015	TM-CB15C-CTL	Sensor cable with connector (15m)
4800254.015H	TM-CB15HC-CTL	High-temperature sensor cable (up to 180°C) with connector (15m)



TM-J-CTL Cooling jacket (length 228mm, ø 89mm) with adjustable mounting bracket TM-JAB-CTL; suitable for ambient temperatures up to 180°C

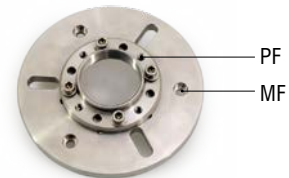

TM-PF-CTL and TM-MF-CTL mounting flange M48x1.5 for directly mounting a CTL sensor

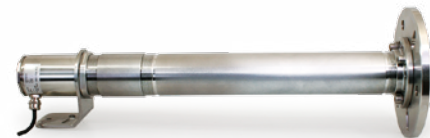

TM-RM-CTL Furnace wall mount accessory for CTLaser / CTratio: TM-MF-CTL, TM-PF-CTL, TM-AST300-CTL and TM-PA-CTL

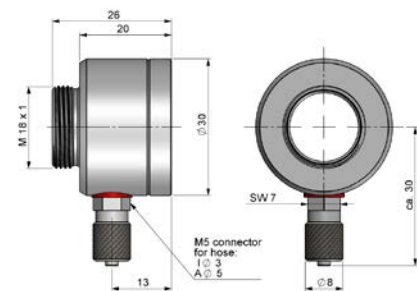

TM-AP-CTR Air purge collar

CTratio		
Art. No.	Model	
2970348	TM-FB-CTR	Mounting bracket, stainless steel, adjustable in one axis
2970395	TM-AP-CTR	Air purge collar, stainless steel
2970373	TM-RM-CTR	Furnace wall mount
2970351	TM-CERT-CTR	Certificate of calibration

Further IR temperature measurement devices from Micro-Epsilon



thermoIMAGER TIM
Compact USB thermal imaging cameras
for precise thermography



thermoMETER CTVideo/CSVideo
Infrared temperature sensors with crosshair
laser sighting and video output



thermoMETER Handheld
Innovative handheld pyrometer with laser
sighting for inspection and maintenance