



More Precision

thermoMETER // Non-contact infrared temperature sensors



High-performance industrial pyrometer thermoMETER UC

Temperature measuring range
from -50 to +1100 °C

High temperature resolution of 50 mK

Analog and digital interfaces

Powerful alarm relays with 400 mA

No cooling required for ambient
temperatures up to 180 °C

Powerful industrial controller



Versatility and robustness meet highest performance

With the thermoMETER UC, Micro-Epsilon offers an extremely powerful system with a wide range of functions and a modern design. It is used for non-contact temperature measurement of objects in machine building and machine design, in production and for quality assurance.

An extremely compact sensor and an industrial-grade controller in an aluminum die-cast housing with IP65 locally separate measurement and evaluation from each other. The sensor can therefore also be used at high temperatures up to 180 °C; and can be installed in a very space-saving manner. In addition, the thermoMETER UC is particularly suitable when measured values are to be processed digitally, e.g. via industrial interfaces.

Easy configuration via buttons & display

The thermoMETER UC has a powerful industrial controller with an integrated LCD display and four input buttons for quick and easy operation. Optionally, the controller can also be conveniently connected to a PC via an industrial USB cable or RS485 and parameterized using the sensorTOOL software.

Minimum wiring effort

Standard M12 connectors are available for the power supply and signal connection, eliminating the need to open the controller. The sensor is pre-wired firmly and available with different cable lengths.

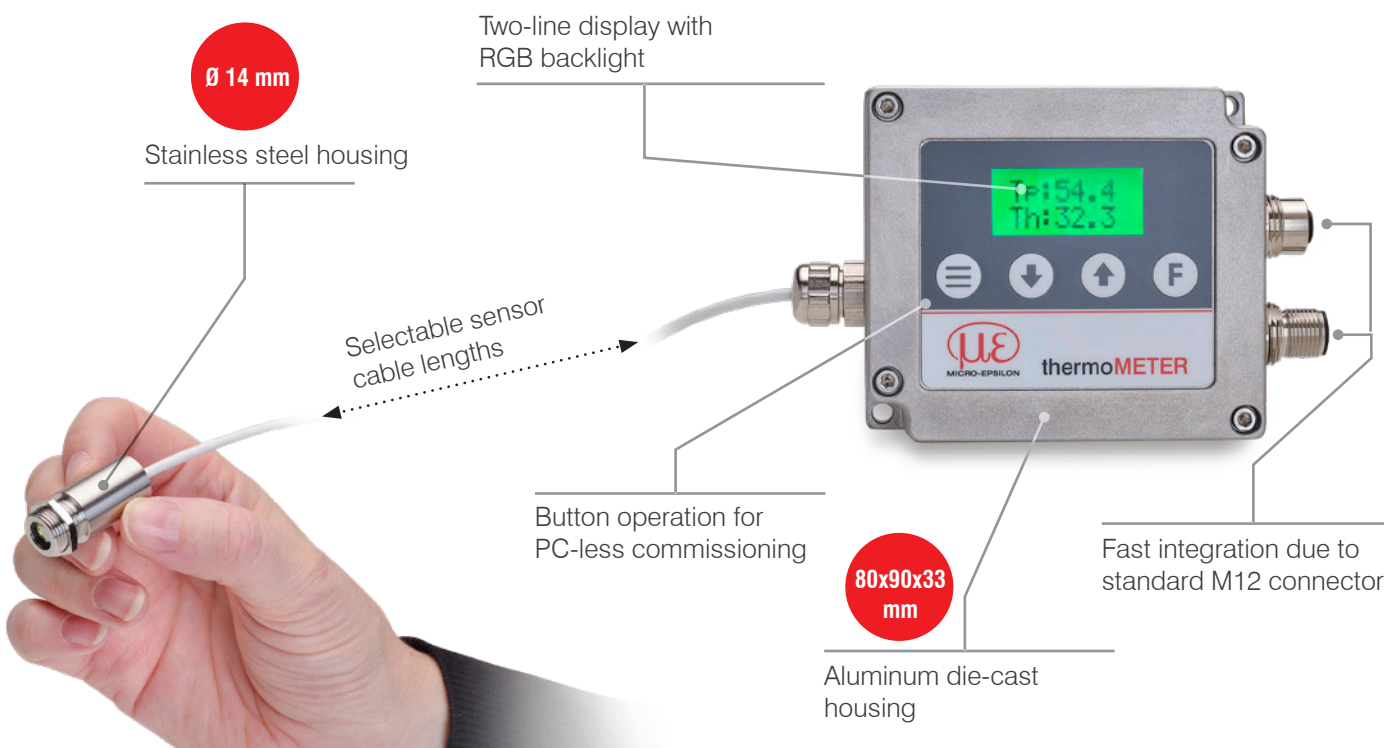

Model		UC-SF02	UC-SF15	UC-SF22
Optical resolution		2:1	15:1	22:1
Measuring range ^[1]		-50 to 600 °C		-50 to 900 °C (1000 °C)
Spectral range		8 to 14 µm		
System accuracy ^[2]		±1.0 % or ±1.0 °C		
Repeatability ^[2]		±0.5 % or ±0.5 °C		
Temperature resolution (NETD) ^[3]		50 mK		
Response time ^[4]		120 ms		
Emissivity		0.100 to 1.100		
Transmittance		0.100 to 1.100		
Signal processing		Intelligent averaging, Min/Max, Hold function with threshold/hysteresis (adjustable via software and buttons)		
Supply voltage		5 ... 36 VDC		
Max. current consumption		< 150 mA		
Digital interface ^[5]		RS485 / USB (3.3V-LVTTL) / Ethernet / EtherCAT / PROFINET / EtherNet/IP		
Analog output ^[6]		0 (4) ... 20 mA / 0 ... 5 V / 0 ... 10 V (freely scalable within the measuring range)		
Switching output		2x relays for alarm (min/max); 400 mA (short-circuit proof)		
Connection	Sensor	Integrated cable, standard length 3 m, optional 1 m, 8 m or 15 m possible		
	Controller ^[7]	Supply/digital and relay output: 8-pin M12 plug connector (socket) Supply/analog output: 5-pin M12 plug connector (plug)		
Mounting		Sensor Direct fastening via integrated M12x1 thread or fastening using the hexagon nut included in the scope of delivery		
Temperature range	Sensor	Storage	-40 ... 85 °C	
		Operation	-20 ... 120 °C	-20 ... 180 °C
	Controller	Storage	-40 ... 85 °C	
		Operation	-20 ... 80 °C	
Humidity		10 % RH ... 95 % RH (non-condensing)		
Shock (DIN EN 60068-2-27)		50g, 11 ms, each axis		
Vibration (DIN EN 60068-2-6)		3g / 11 ... 200 Hz, each axis		
Protection class (DIN EN 60529)	Sensor	IP65		
	Controller	IP65		
Material	Sensor	Stainless steel (1.4404)		
	Controller	Aluminum die-cast		
Weight	Sensor	approx. 20 g		
	Controller	approx. 280 g		
Control and indicator elements ^[8]		LCD display & membrane keypad for button operation optional operation via sensorTOOL		

^[1] Measuring range can optionally be extended to 1000 °C (only SF22)

^[2] Valid for object temperatures >0 °C and for an ambient temperature of 24 °C ±2 °C; the greater value applies (ε=1)

^[3] With a time constant of 200 ms and an object temperature of 200 °C

^[4] 0 - 90 % energy; adjustable via software

^[5] Connection via an interface module is required for Ethernet, EtherCAT, PROFINET and EtherNet/IP, USB interface only via USB cable (see accessories)

^[6] Depends on supply voltage

^[7] The supply via the optional USB cable (VCC = 5 V) and the supply up to 36 V can be connected at the same time; the higher voltage supply is used in each case. When operating without a USB cable, the power supply up to 36 V can be connected to one of the two M12s.

^[8] Access with sensorTOOL requires USB adapter (see accessories)

Product identification

UC-	SF15-	S3
Cable length: 1m / 3 m (standard) / 8 m / 15 m		
Focus: SF02 / SF15 / SF22		
Series: thermoMETER UC		

Standard Focus (in mm)

		7	53.8	102.5	151.3	200	251.3	302.5	353.8	405		
SF02	2:1	7	53.8	102.5	151.3	200	251.3	302.5	353.8	405		
Distance		0	100	200	300	400	500	600	700	800		
SF15	15:1	7	11.5	14	18	23.5	29.5	35.5				
Distance		0	100	200	300	400	500	600				
SF22	22:1	7	14	12	18.5	23	28	33	36.5	38.5	40	41.5
Distance		0	60	110	210	310	410	510	610	710	810	910

Close Focus (when using the screwable CF lens, in mm)

		6.5	3.9	2.8	2.5	4.8	6.4	8
CF02	2:1	6.5	3.9	2.8	2.5	4.8	6.4	8
Distance		0	10	20	25	30	35	40
CF15	15:1	6.5	3.7	0.8	4.1	5	6.8	8.8
CF22	22:1	6.5	3.4	0.6	4	4.5	6.2	8
Distance		0	5	10	15	20	25	30

 = smallest spot size / focal point (mm)

The ratio D:S (example 2:1, see table) describes the ratio Distance (distance from the front edge of the sensor to the measuring object) to Spot size (measurement spot size).

Technical drawings

thermoMETER

thermoMETER UC

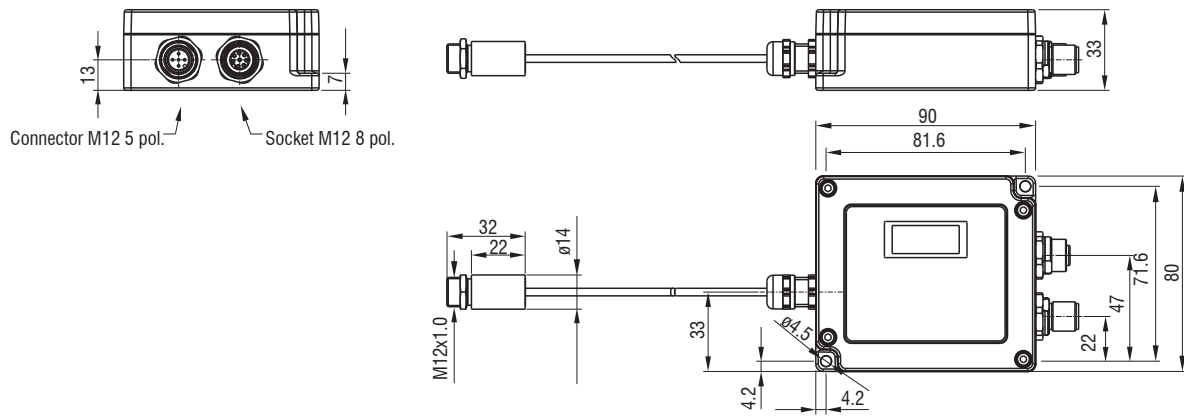

thermoMETER SE

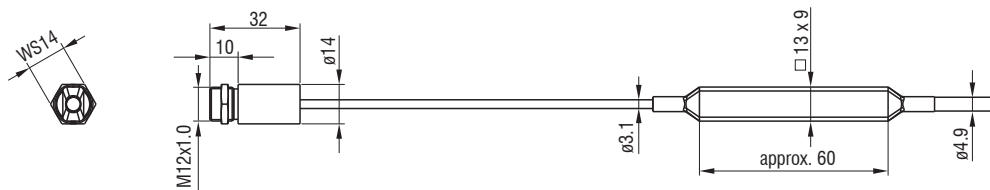

thermoMETER FI

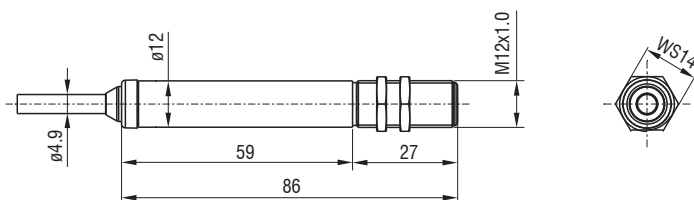

(dimensions in mm, not to scale)

Connection possibilities

thermoMETER

Sensor	Cables	Type
thermoMETER FI	Integrated cable Length 1 m / 3 m / 8 m / 15 m	Open ends (with ferrules)



Connection possibilities and accessories	
Connection supply voltage PS2020	
USB programming adapter for connection to PC TM-USBA USB adapter with terminal block	
Interface module for Ethernet and EtherCAT connection IF1032	
Control / machine Analog output (voltage), open collector	

Sensor	Cables	Type
thermoMETER SE	Sensor cable (sensor controller) Lengths 0.5 m / 3 m / 6 m / 15 m Connection cable (Controller - open ends) Lengths 0.5 m / 3 m	Open ends (with ferrules)



Connection possibilities and accessories	
Connection supply voltage PS2020	
USB programming adapter for connection to PC TM-USBA USB adapter with terminal block	
Interface module for Ethernet and EtherCAT connection IF1032	
Control / machine Analog output (current/voltage), open collector	

Sensor	Cables	Type
thermoMETER UC	Digital cable: TM-DC8/x-M12 Lengths 1 m / 5 m	Open ends (with ferrules)
	Digital cable: TM-USBA-M12 Length 1.8 m	USB
	Analog cable: TM-PC5/x-M12 Lengths 1 m / 5 m	Open ends (with ferrules)



Connection possibilities and accessories	
Connection supply voltage PS2020	
USB programming adapter for connection to PC TM-USBA USB adapter with terminal block	
Control / machine 2x alarm relays, RS485	
Interface module for Industrial Ethernet connection IF2035-PROFINET IF2035-EIP IF2035-EtherCAT	
Connection to PC (sensorTOOL) Display & parameter setting	
Interface module for Ethernet and EtherCAT connection IF1032	
Connection supply voltage PS2020	
Control / machine Analog output (current/voltage)	

Mounting accessories / optical accessories / air purge collars

Art. no.	Name		FI	SE	UC
2970750	TM-DIN-UC	Rail mount adapter	⊗	⊗	✓
2970751	TM-MF-UC	Mounting fork	⊗	✓	✓
2970752	TM-APL	Air purge collar, laminar	✓	✓	✓
2970753	TM-FB	Mounting bracket	✓	✓	✓
2970754	TM-AB-UC	Mounting bracket, adjustable in 2 axes	⊗	✓	✓
2970755	TM-MB-UC	Mounting bolt with M12x1 thread and nut	⊗	✓	✓
2970756	TM-TA	Pipe adapter	✓	✓	✓
2970757	TM-T40	Reflection protection tube, length 40 mm; M12x1 external thread	✓	✓	✓
2970758	TM-T88	Reflection protection tube, length 88 mm; M12x1 external thread	✓	✓	✓
2970759	TM-T20	Reflection protection tube, length 20 mm; M12x1 external thread	✓	✓	✓
2970760	TM-MH-UC	Massive housing made from stainless steel	⊗	✓	✓
2970761	TM-FBMH-UC	Mounting bracket for solid housing	⊗	✓	✓
2970762	TM-APMH-UC	Air purge collar made from stainless steel for solid housing	⊗	✓	✓
2970763	TM-CF	Close Focus lens	✓	✓	✓
2970764	TM-PW	Protective window	✓	✓	✓
2970765	TM-AP-UC	Air purge collar (stainless steel) for lenses from D/S 15:1	⊗	⊗	✓
2970766	TM-AP2-UC	Air purge collar (stainless steel) for lenses with D/S 2:1	⊗	⊗	✓
2970767	TM-AP	Air purge collar	✓	✓	✓
2970768	TM-AP8	Air purge collar with 8 mm hose connection	✓	✓	✓
2970769	TM-MI	Right angle mirror	✓	✓	✓

Connection cables for pyrometer UC

2904051	TM-PC5/1-M12	Analog signal and supply cable 1 m
2904052	TM-PC5/5-M12	Analog signal and supply cable 5 m
2904053	TM-USBA-M12	Digital signal cable with USB converter, 1.8 m, M12 plug, USB-A plug
2904054	TM-DC8/1-M12	Digital signal cable, 1 m, M12 plug, ferrules, pre-assembled
2904055	TM-DC8/5-M12	Digital signal cable, 5 m, M12 plug, ferrules, pre-assembled

USB adapter for pyrometers UC / FI / SE

2970770	TM-USBA	USB adapter with terminal block
---------	---------	---------------------------------

IF2035: Interface module for Industrial Ethernet connection

- Connection of RS422 or RS485 interfaces to PROFINET / Ethernet/IP / EtherCAT
- Synchronization output for RS422 sensors
- 2 network connections for different network topologies
- Data rate up to 4 MBaud
- 4-fold oversampling (with EtherCAT)
- Ideal for confined spaces due to a compact housing and DIN rail mounting

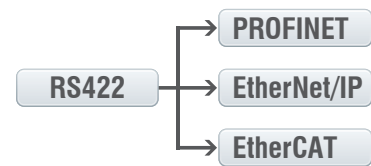

IF1032: Interface module for Ethernet & EtherCAT connection

- Connection of analog output or RS485 to Ethernet and EtherCAT
- Web interface for data display and scaling
- CSV export



Sensors and Systems from Micro-Epsilon



Sensors and systems for displacement, distance and position



Sensors and measurement devices for non-contact temperature measurement

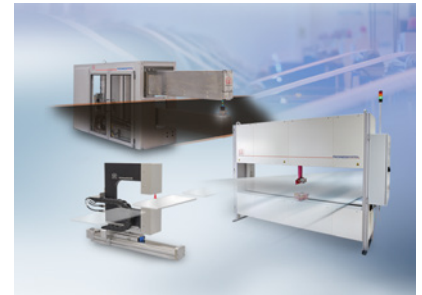

Measuring and inspection systems for metal strips, plastics and rubber



Optical micrometers and fiber optics, measuring and test amplifiers



Color recognition sensors, LED analyzers and inline color spectrometers

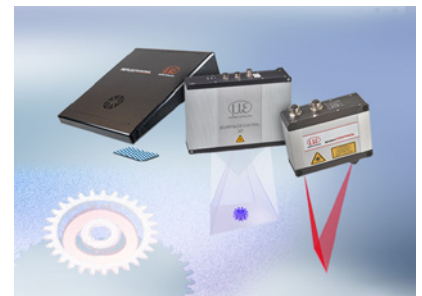

3D measurement technology for dimensional testing and surface inspection